

Draw who  
you see



STEM is for Everyone

# FUTUREyou

*Draw who you see* is an activity book for kids from Future You, an initiative from the Australian Government's Women in STEM Ambassador.

Future You addresses stereotypes, misconceptions and biases about science, technology, engineering and mathematics (STEM). It's a free program designed to increase participation in STEM by inspiring kids aged 8 to 12 to explore STEM themes.

Find out more at:  
[www.futureyouaustralia.com.au](http://www.futureyouaustralia.com.au)



An Australian Government Initiative

---

**Women in STEM  
Ambassador**

Future You is funded by the Commonwealth Department of Industry, Science and Resources



## **Hey kids!**

Use your creativity and draw whoever (or whatever) comes to mind for each page.

### **A note for adults:**

Talking to kids about stereotypes is important. That's because stereotypes can have a big impact on job opportunities and pay. They can influence whether a person applies for a job, gets hired, or is promoted. It can also affect how they are treated at work.

We all deserve to live in a world where people are valued for their skills, regardless of who they are. By having conversations with kids about stereotypes, we can help create a society where everyone is respected for the work they do.

So, use this colouring-in book and have a conversation with your kids about stereotypes. Remember, there are no right or wrong drawings.

Ask your child questions about their drawing. For example, you could ask who they drew and why they drew that person. Invite them to think about other types of people who could do that job.

**Be the solution.**

## Draw a playground (structural) engineer:

A playground engineer is like a dream maker for fun places. They design playgrounds with slides, swings, and climbing things, making sure they're super safe and exciting for kids to play on.

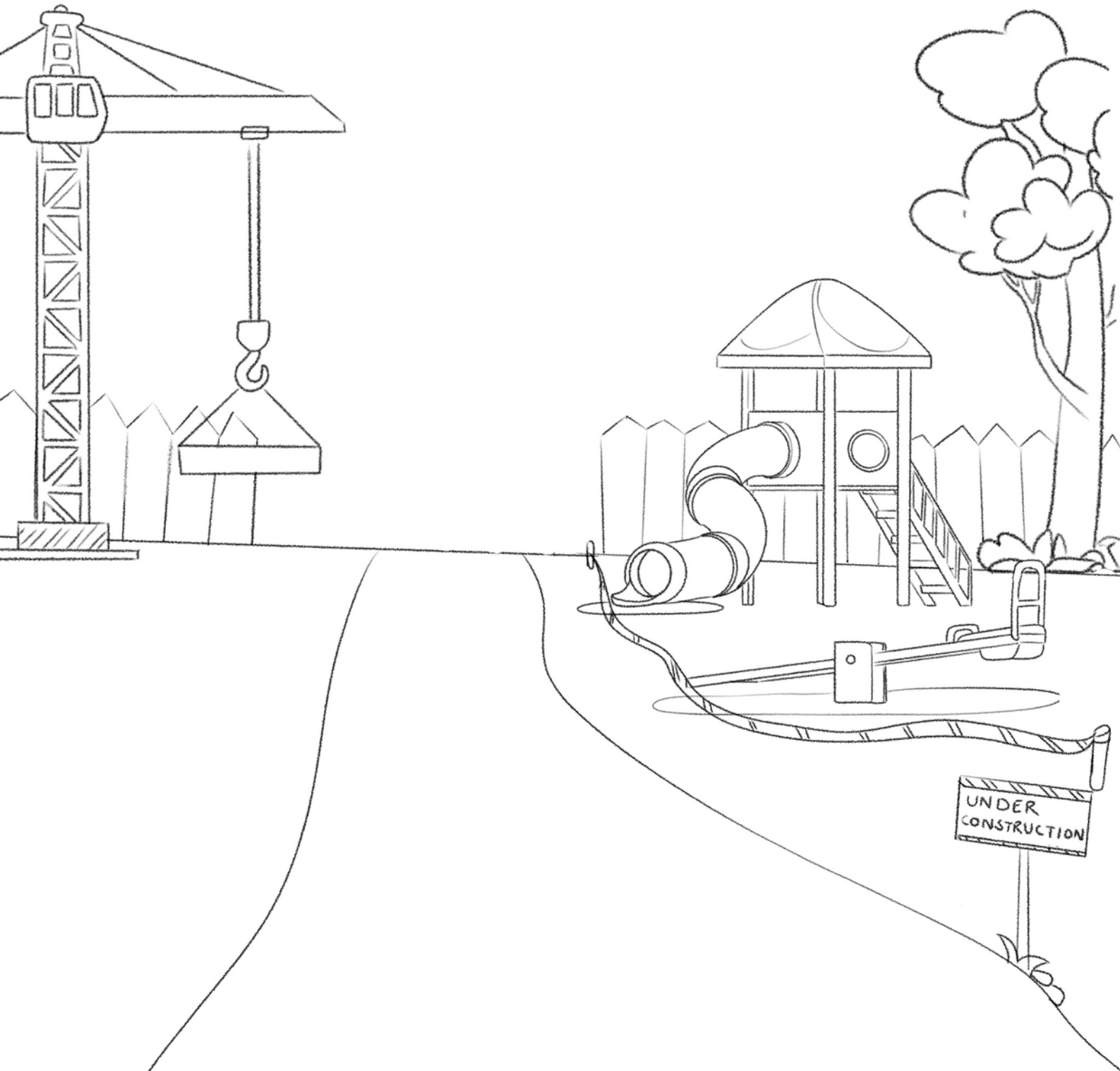

Now, draw someone completely different as a playground (structural) engineer.

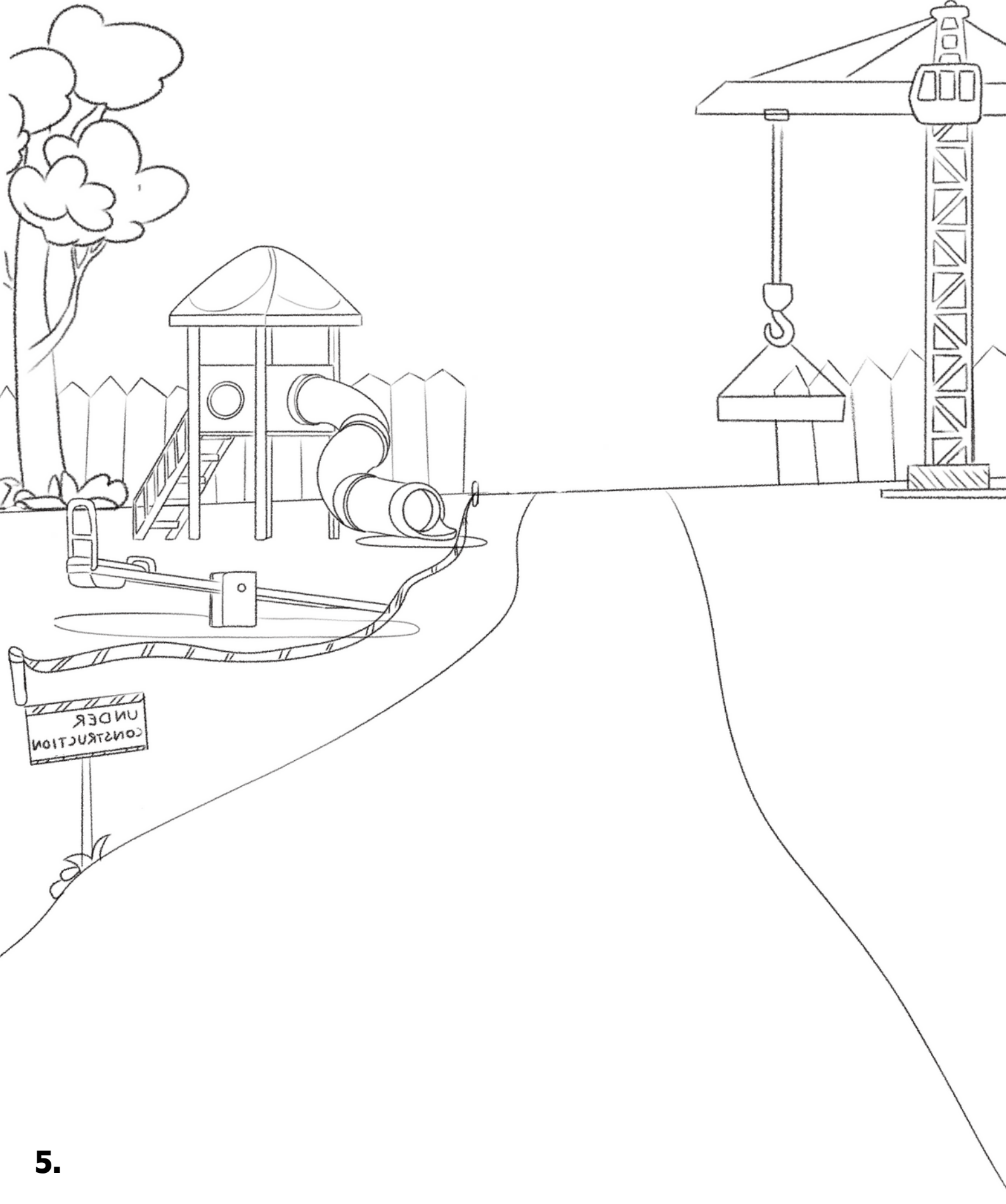

### **Draw a surveyor:**

A surveyor is like a map maker. They go outside with special tools to measure and draw places like land, buildings, and roads. They help us find our way and plan things better.

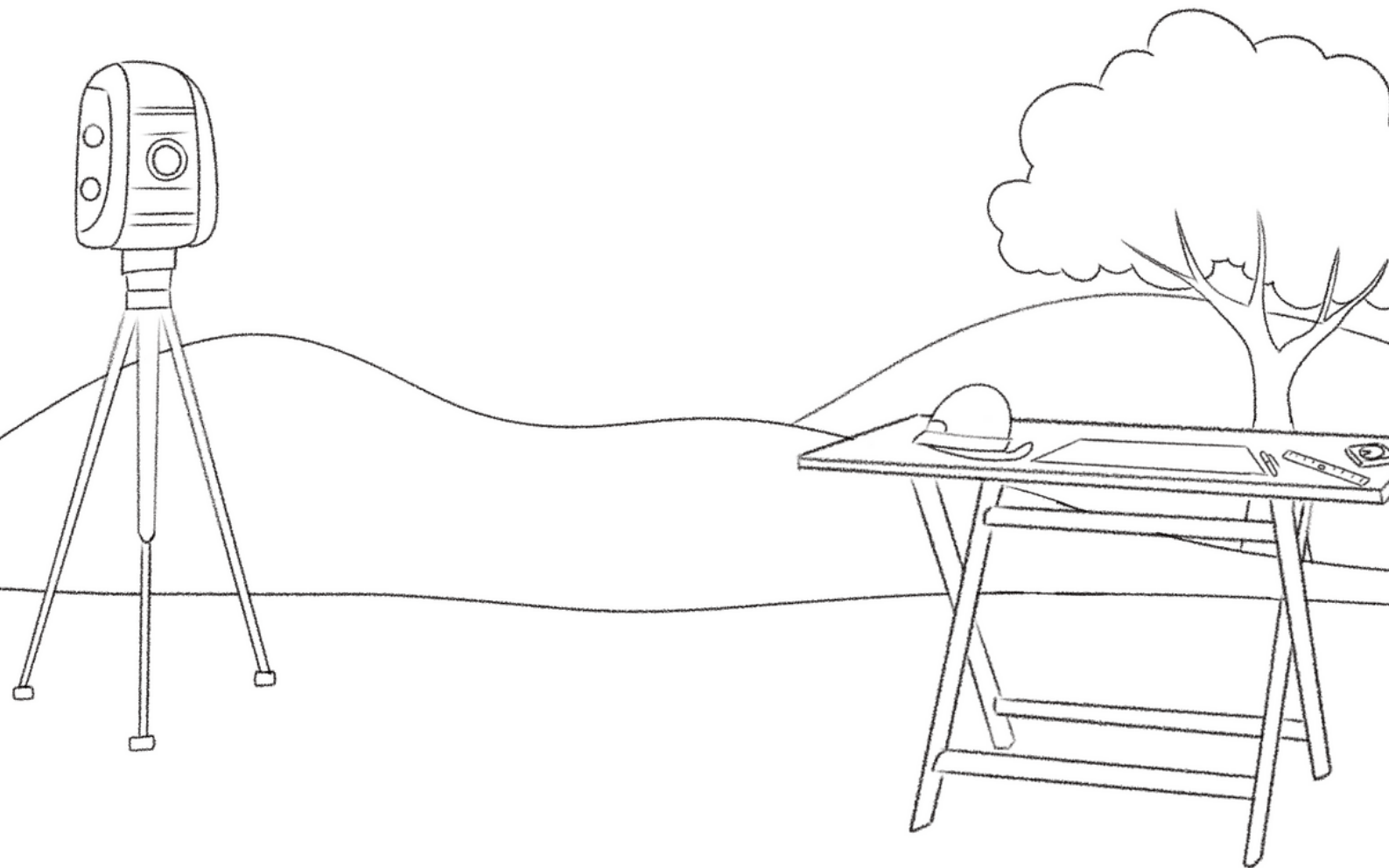

**Now, draw someone completely different as a surveyor.**

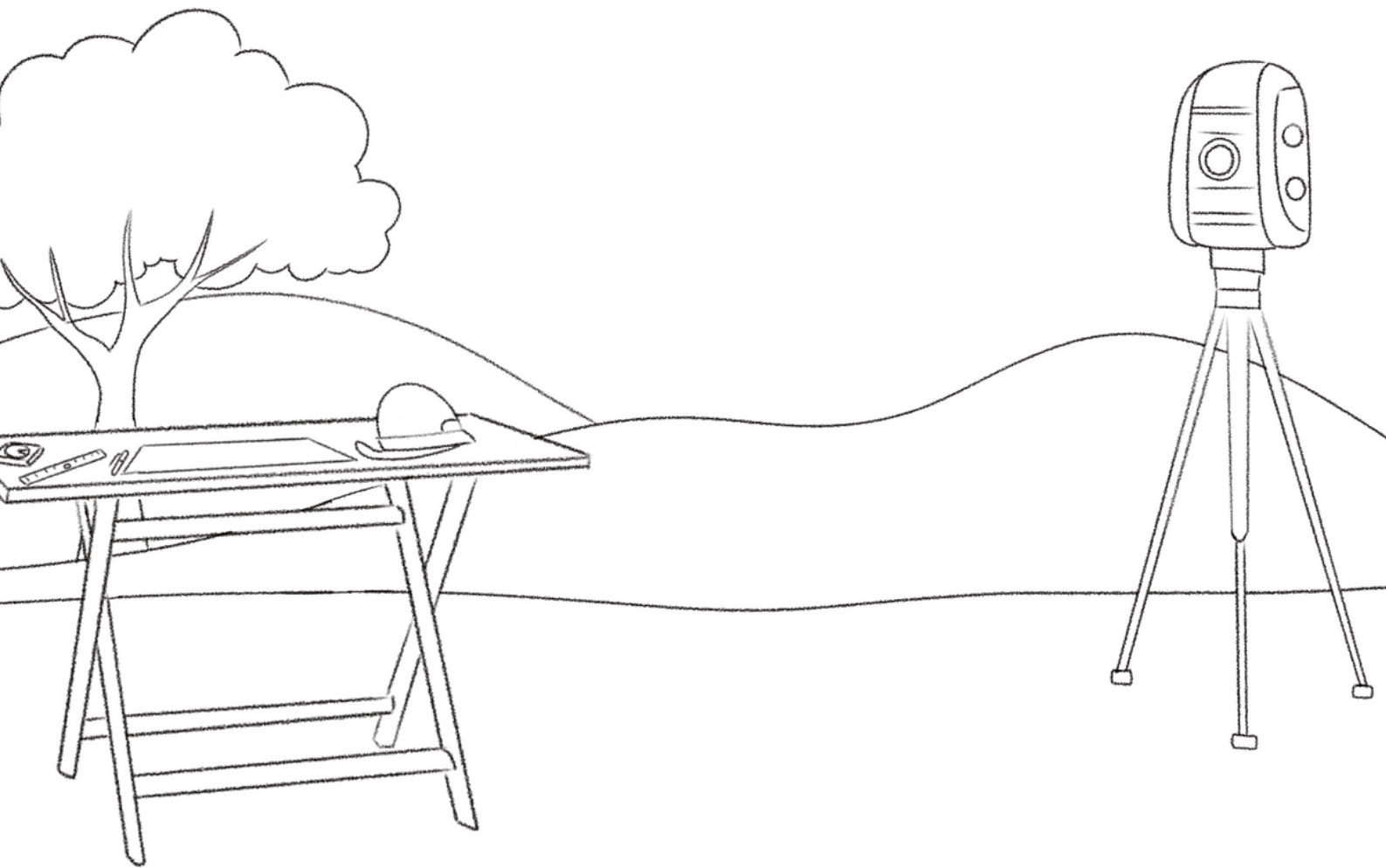

### Draw a welder:

A welder is like a metal magician. They use a special tool that makes fiery sparks to join metal pieces together to build things like strong bridges or metal art such as sculptures.

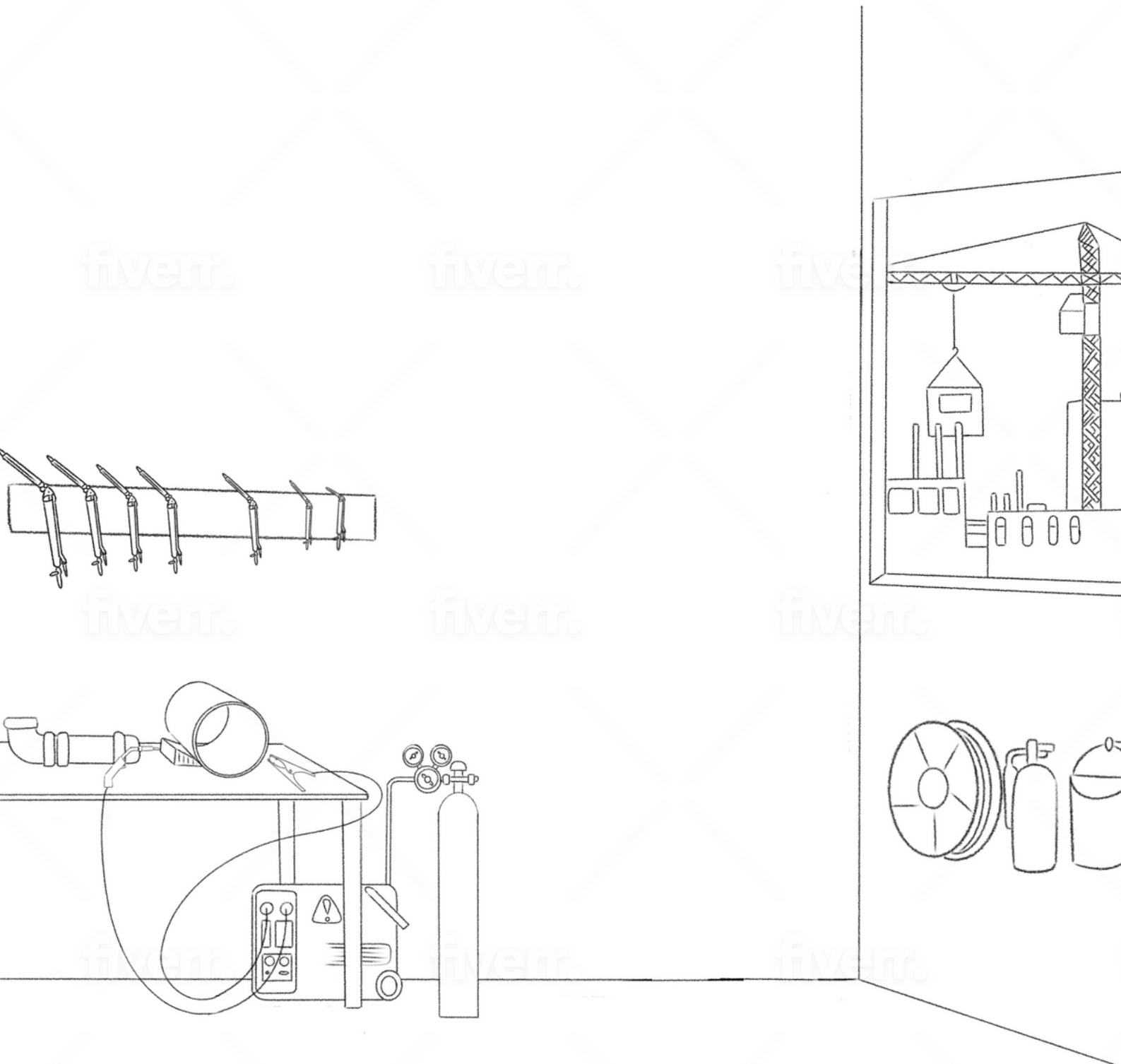



Now, draw someone completely different as a welder.

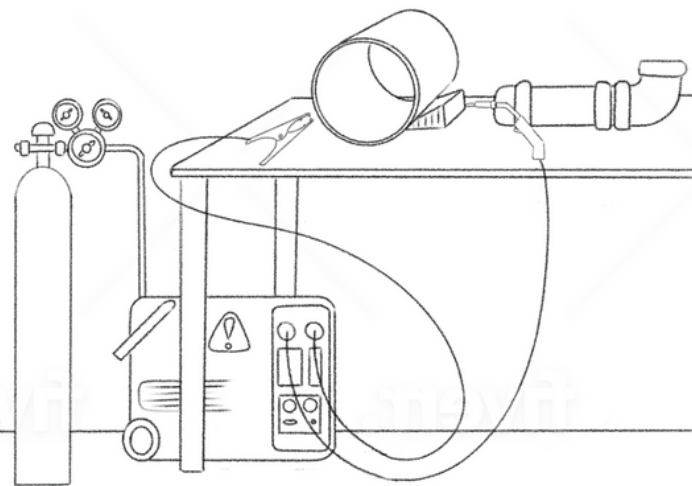
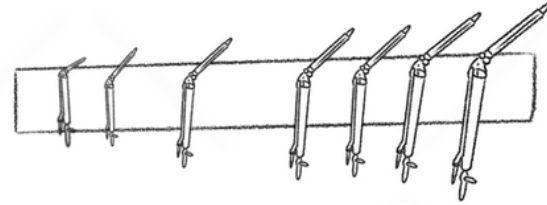
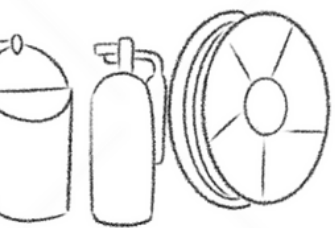
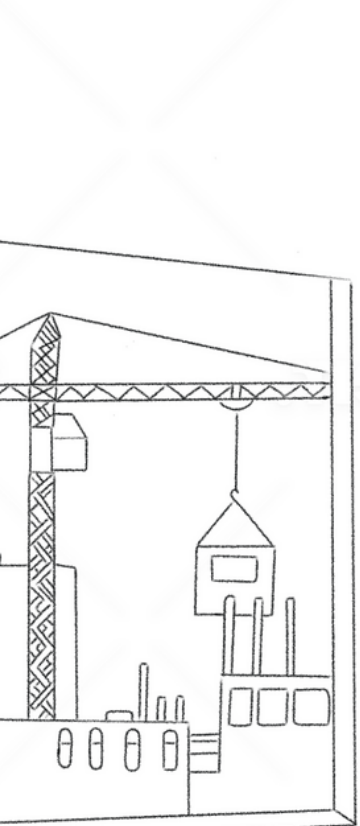

## Draw an agronomist:

An agronomist is like a plant scientist. They know everything about how to grow tasty food like fruits, vegetables, and grains. They help farmers make sure we have yummy things to eat.

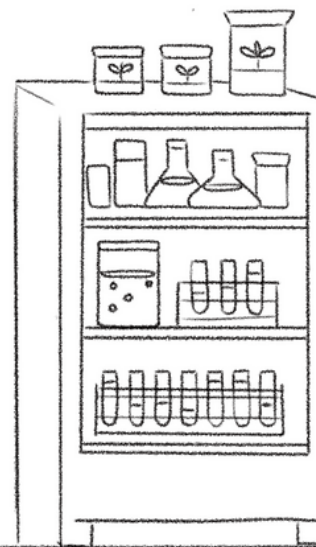
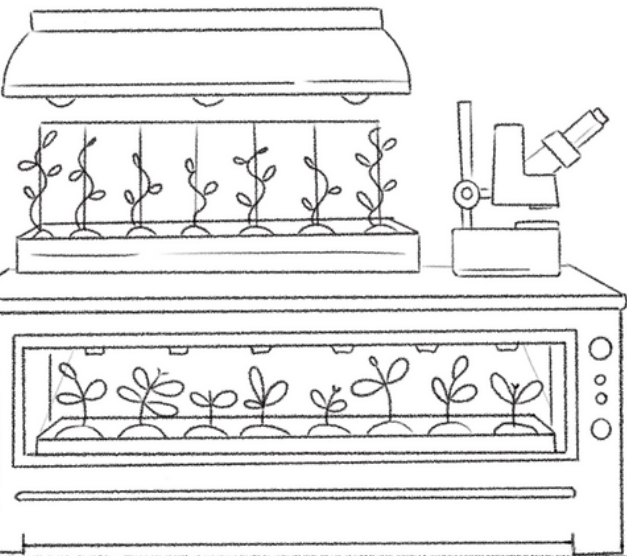
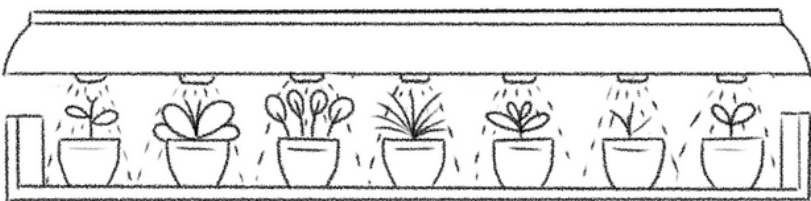

**Now, draw someone completely different as an agronomist.**

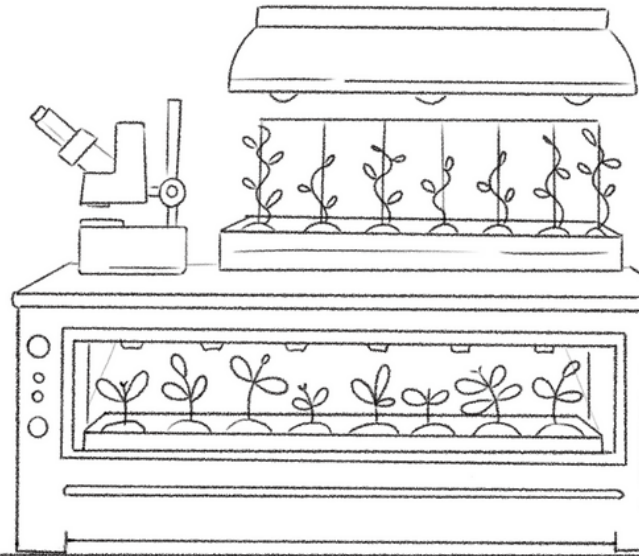
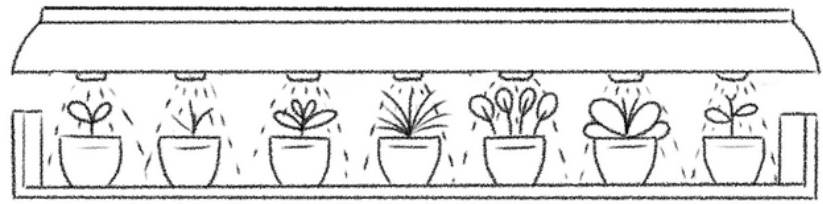

## Draw a palaeontologist:

A palaeontologist is like a time traveller who studies ancient creatures. They find and learn about fossils – the remains of dinosaurs and other animals from long ago.

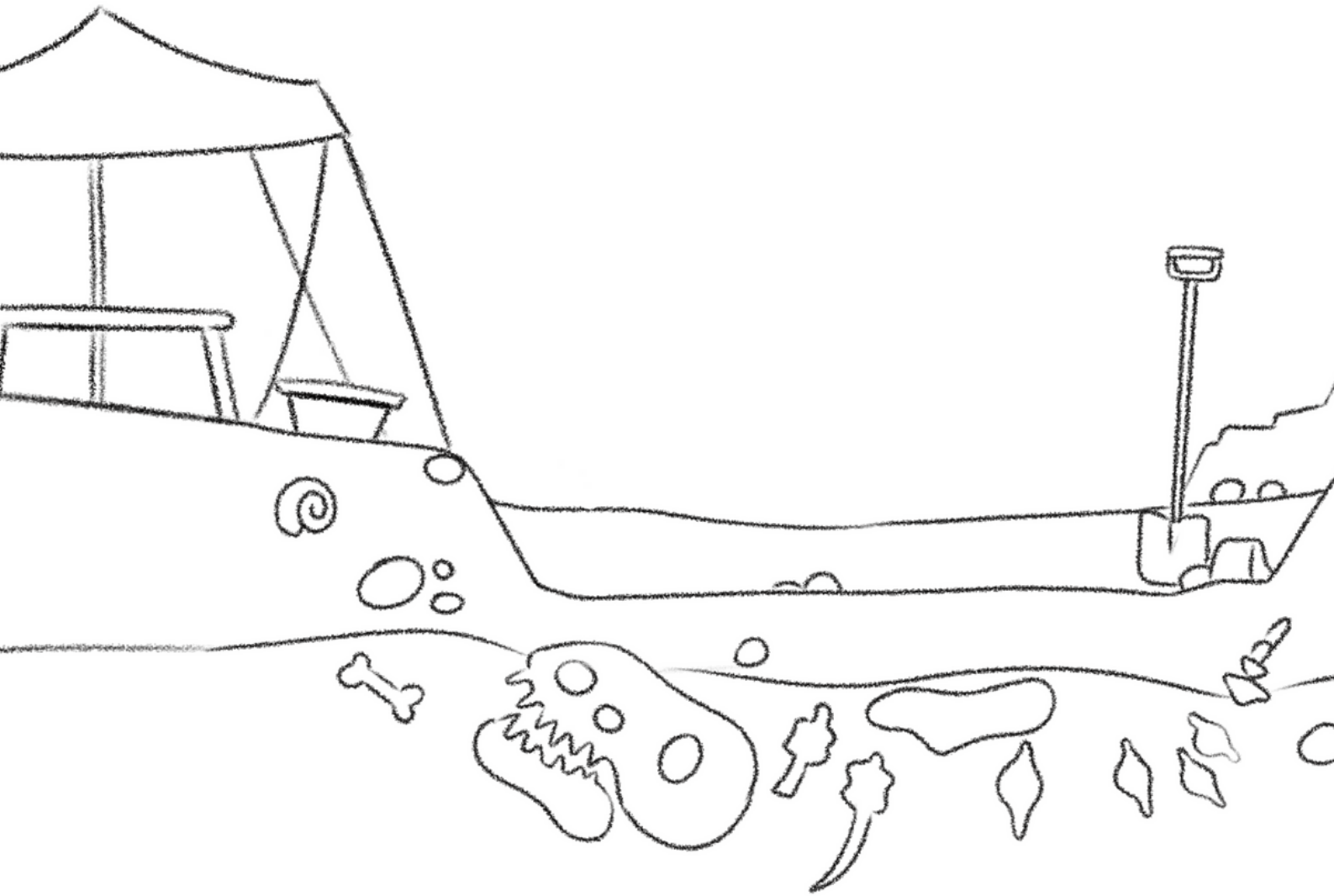

**Now, draw someone completely different as a palaeontologist.**

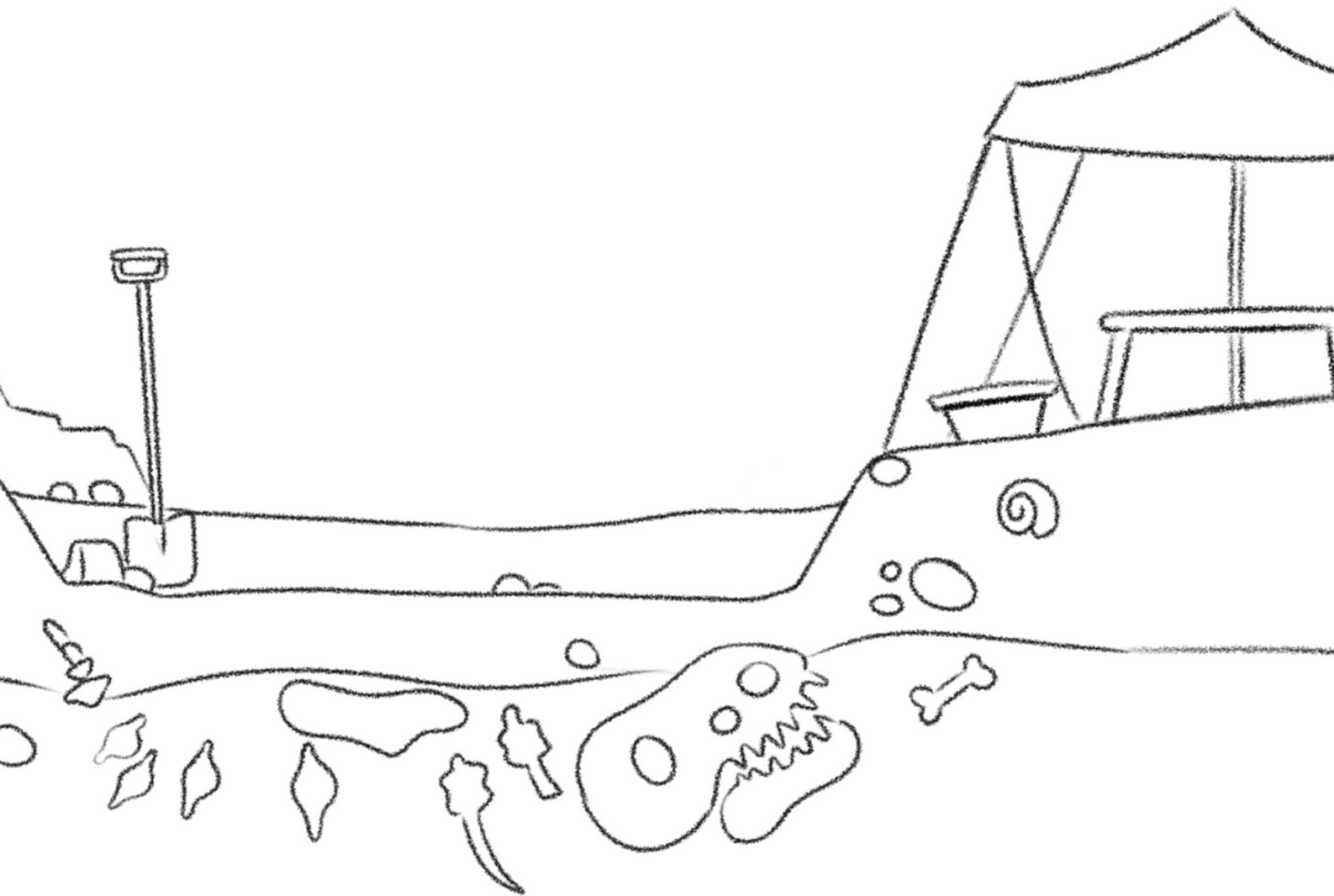

### Draw a warehouse team leader:

A warehouse team leader is like a puzzle master assembling a complex jigsaw. They guide a team that keeps a big storage place in order, like a giant puzzle. Everything has its special spot, and they make sure things are safe and ready to be found when needed.

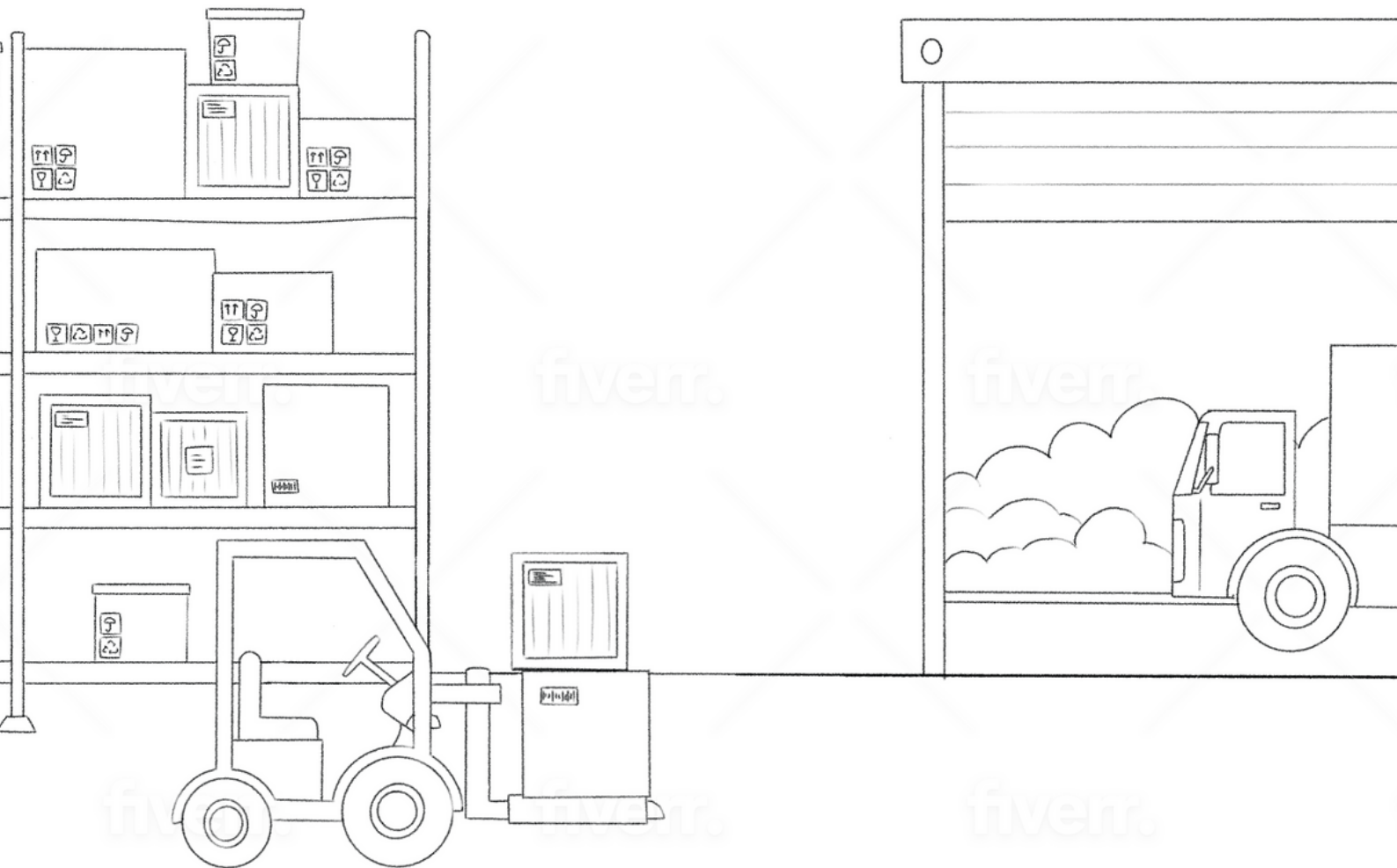

**Now, draw someone completely different as a warehouse team leader.**

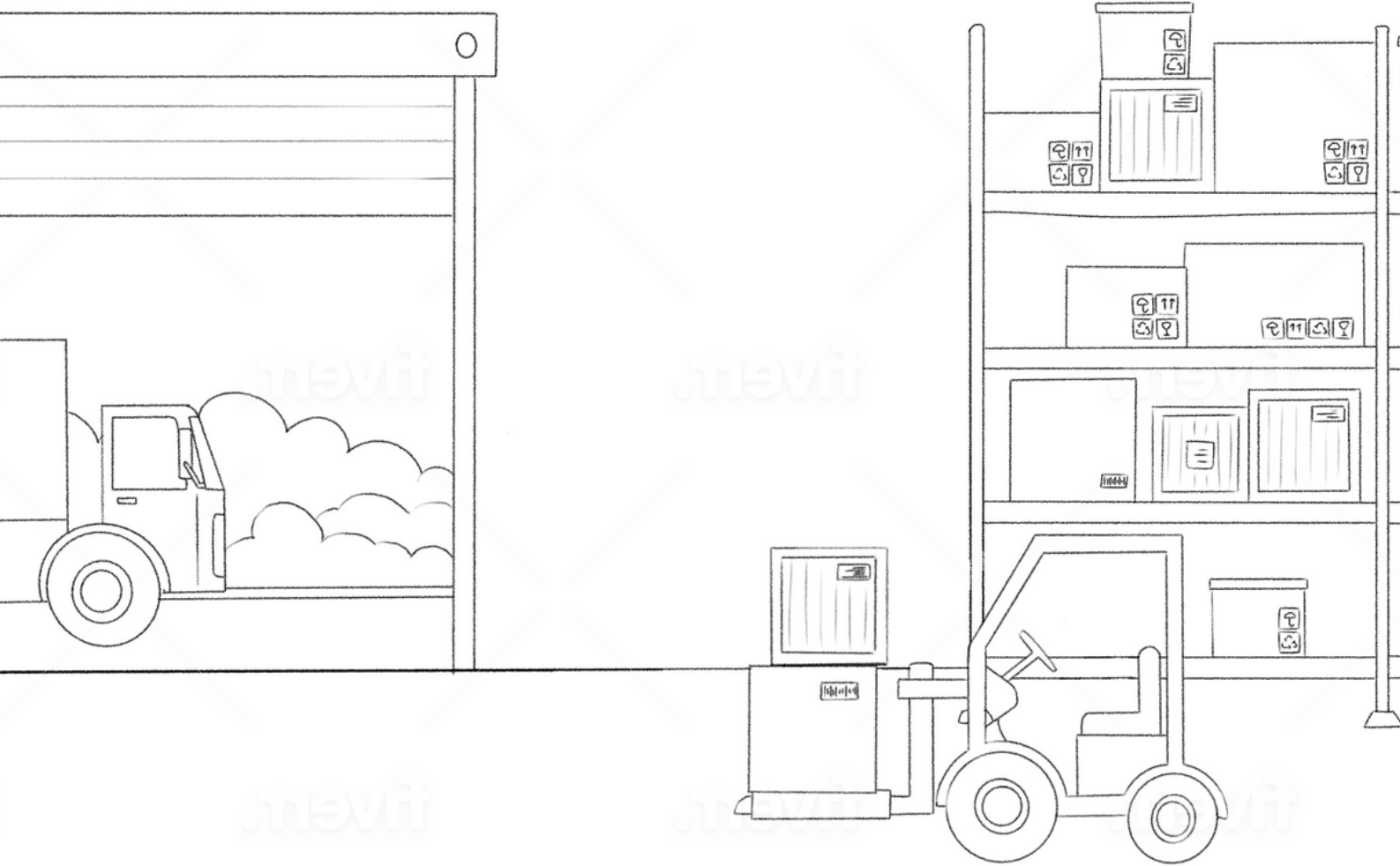

## Draw a solar panel installer:

A solar panel installer puts up special panels on roofs and fields. These panels soak up the Sun's energy and turn it into electricity, like magic sunlight machines. By doing this, they help the Earth stay cleaner and brighter!

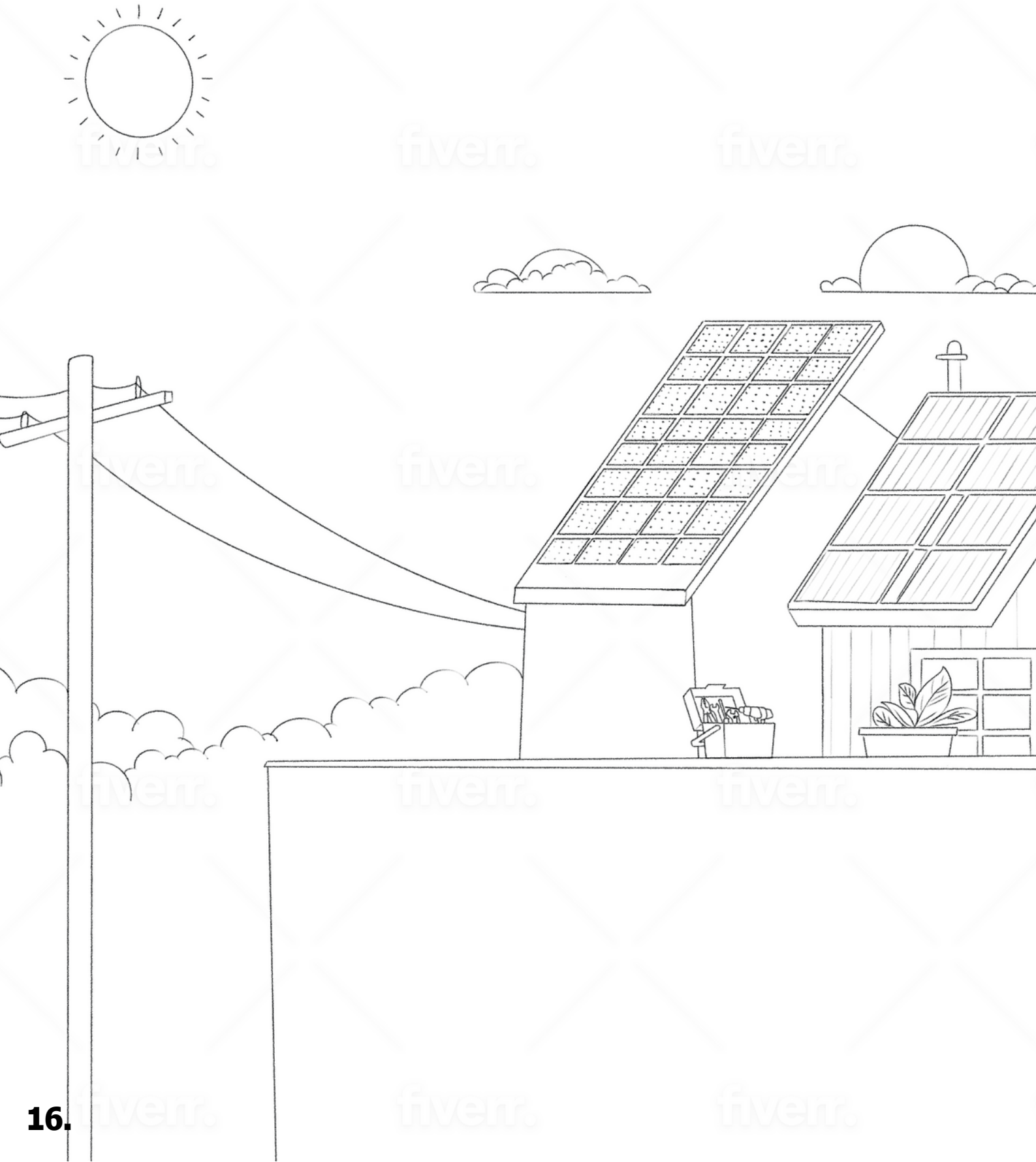



**Now, draw someone completely different as a solar panel installer**

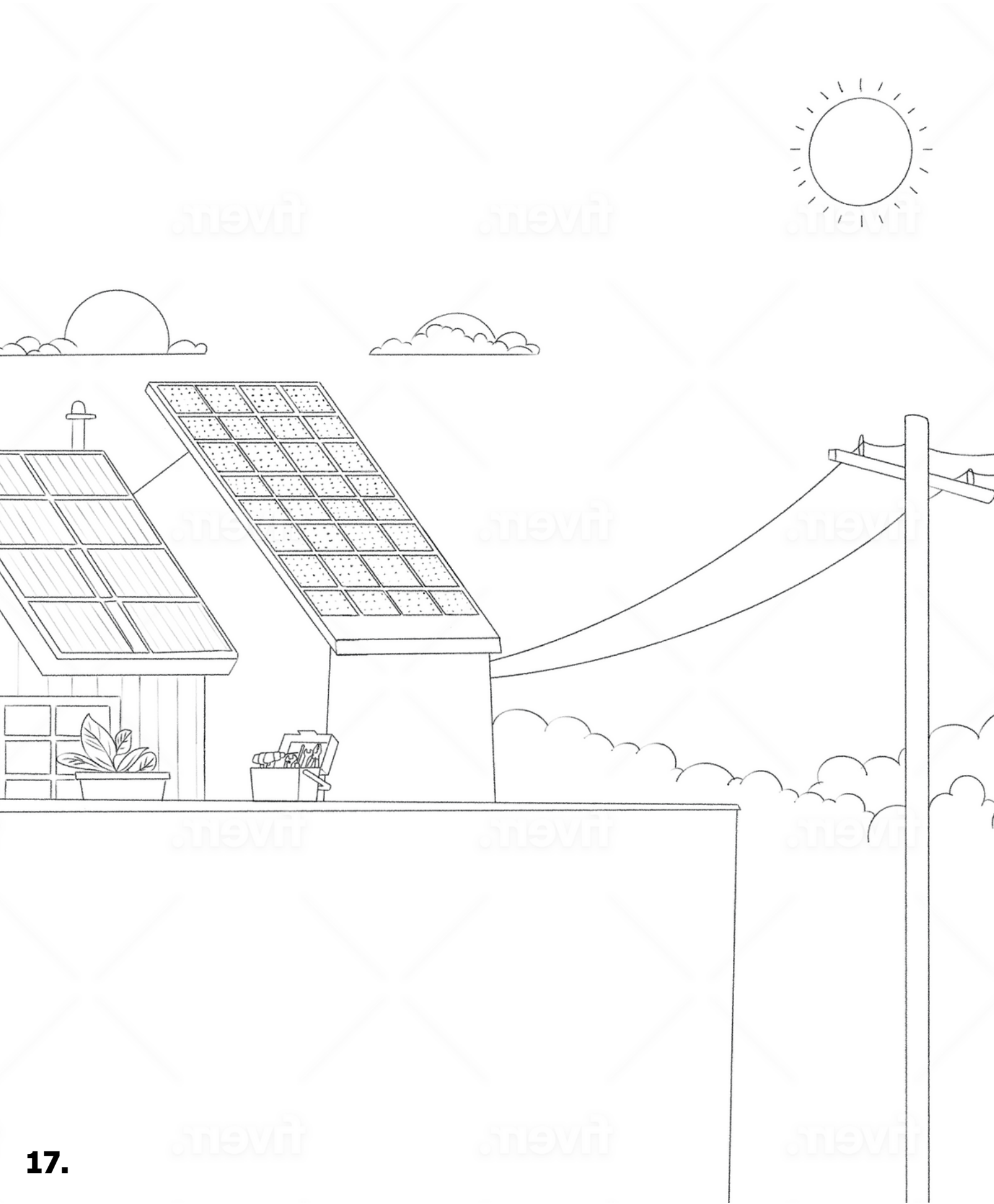

## Draw a cloud security engineer:

A cloud security engineer creates special shields and locks in the online world to protect important information, such as our passwords, bank accounts, and our privacy.



**Now, draw someone completely different as a cloud security engineer.**



# Edition 1

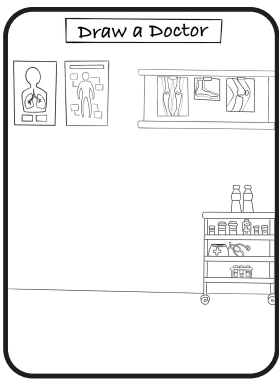

**Doctor:** A doctor is like a superhero for our bodies. They help us when we're sick or hurt. They use their important knowledge to make us feel better and keep us healthy.

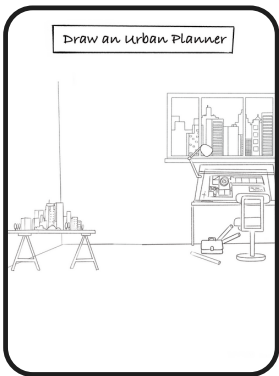

**Drone pilot:** A drone pilot is like a captain of a tiny flying robot called a drone. They use remote controls to make the drone go up in the sky, take cool pictures, or help keep an eye on things from above.

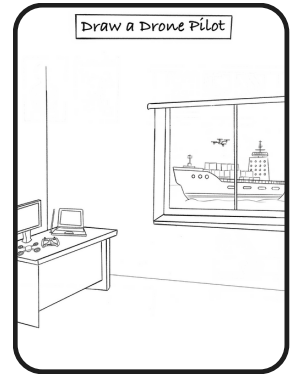

**Urban planner:** An urban planner is like a city creator. They decide how cities should look and grow, making sure houses, parks, and roads are in the right places to make people's lives happy and comfortable.

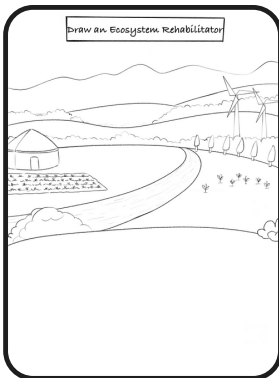

**Gemmologist:** A gemologist is like a treasure hunter for valuable rocks and rare gems. They study and evaluate gemstones based on their properties, quality, and value.

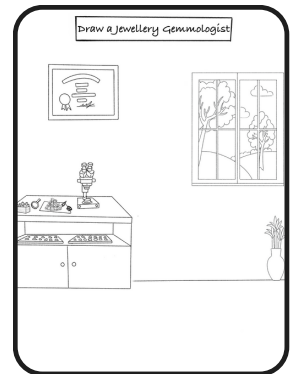

**Ecosystem rehabilitator:** An ecosystem rehabilitator is like a nature doctor. They take care of places where plants and animals live, helping them heal when they're hurt, planting new things, and ensuring all creatures have a safe and happy home.

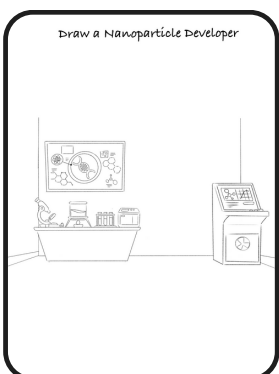

**Radio astrophysicist:** A radio astrophysicist is a space explorer with special eyes. They spot invisible signals coming from space to learn about stars, planets, and galaxies far, far away.

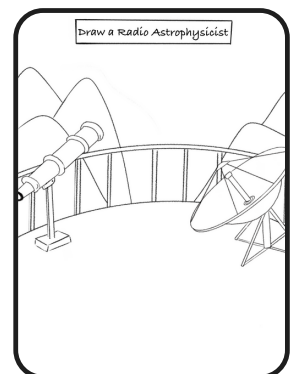

**Space chef:** A space chef is like a cook who makes food for astronauts in space. They prepare nutritious meals so that astronauts can have tasty dinners even in outer space.

# Edition 2

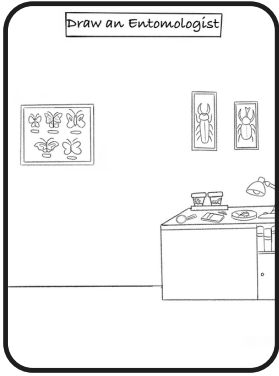

**Entomologist:** An entomologist is like a bug detective. They study all sorts of insects, like butterflies, ants, and beetles. They help us learn more about these tiny creatures and how they live in our world.

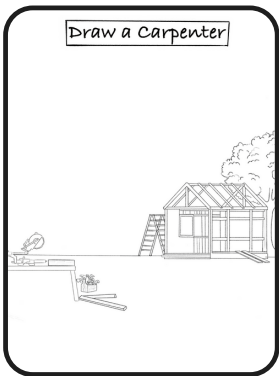

**Data detective:** A data detective is like a mystery solver using numbers and information. They search through lots of computer data to find clues and patterns, helping us understand secrets and stories hidden in data.

**Carpenter:** A carpenter is like a super builder. They use their tools to cut and shape wood into amazing things, like tables, chairs, and even houses. They help make our world cozy and strong!

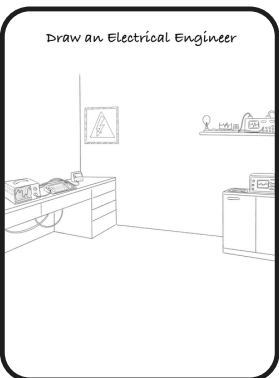

**Destructive tester:** A destructive tester is like a superhero scientist who breaks things on purpose. They do this to see how strong things are and how they can be made even better and safer in the future.

**Electrical engineer:** An electrical engineer is like a magician of electricity. They figure out how to make lights turn on, phones charge, and gadgets work by using their special knowledge about how electricity flows.

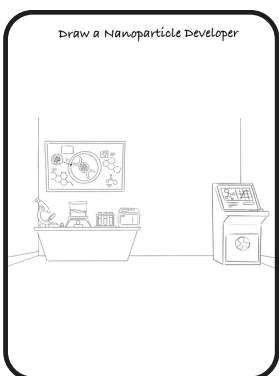

**Renewable energy product researcher:** A renewable energy product researcher is like an inventor who looks for cool ways to use the sun, wind, and other kinds of energy that won't run out. They help find new ways to power our homes and cars without hurting the planet.

**Nanoparticle developer:** A nanoparticle developer is a scientist who works with really tiny things. They make really, really small particles that can do big things, like helping to cure diseases or making materials super strong.

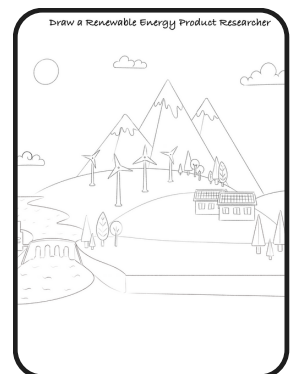
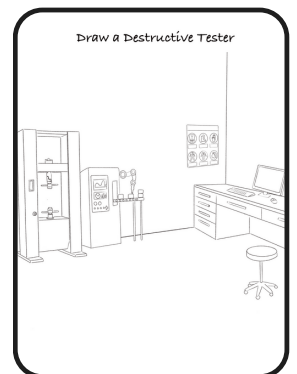
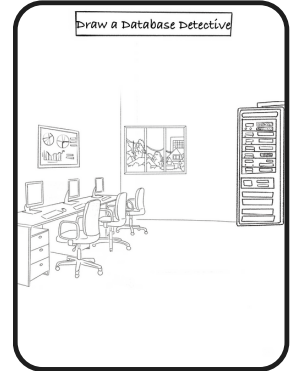

# FUTUREyou

*Draw who you see* is a series of colouring-in activity books that challenge stereotypes about science, technology, engineering and mathematics jobs.

These books can also be used to start important conversations with children about these stereotypes in order to create a more equal and fair society where everyone is respected for the work they do.

You can access the rest of the *Draw who you see* series for free at:  
[www.futureyouaustralia.com.au/resources](http://www.futureyouaustralia.com.au/resources)

The *Draw who you see* series.

Edition 1

Edition 2

Edition 3

Future You is an initiative from the Australian Government's Women in STEM Ambassador, funded by the Australian Government's Department of Industry, Science and Resources.



An Australian Government Initiative

---

**Women in STEM  
Ambassador**